

NA-K 6000 VA

(45.600)

Voltage	(V)	400	Water capacity	(Liter)	390
Motor	(kW)	7,5	Water connection		G ¾"
Current (400V/50Hz)	(A)	14,4	Intake / Outlet diameter	(mm)	280/300
Fuse	(A)	32	Weight (without water)	(kg)	530
max. negative pressure	(Pa)	3.600	Dust collection bin	(Liter)	50
max. airflow	(m³/h)	5.150	Dimensions (l x w x h)	(mm)	950 x 950 x 3,530

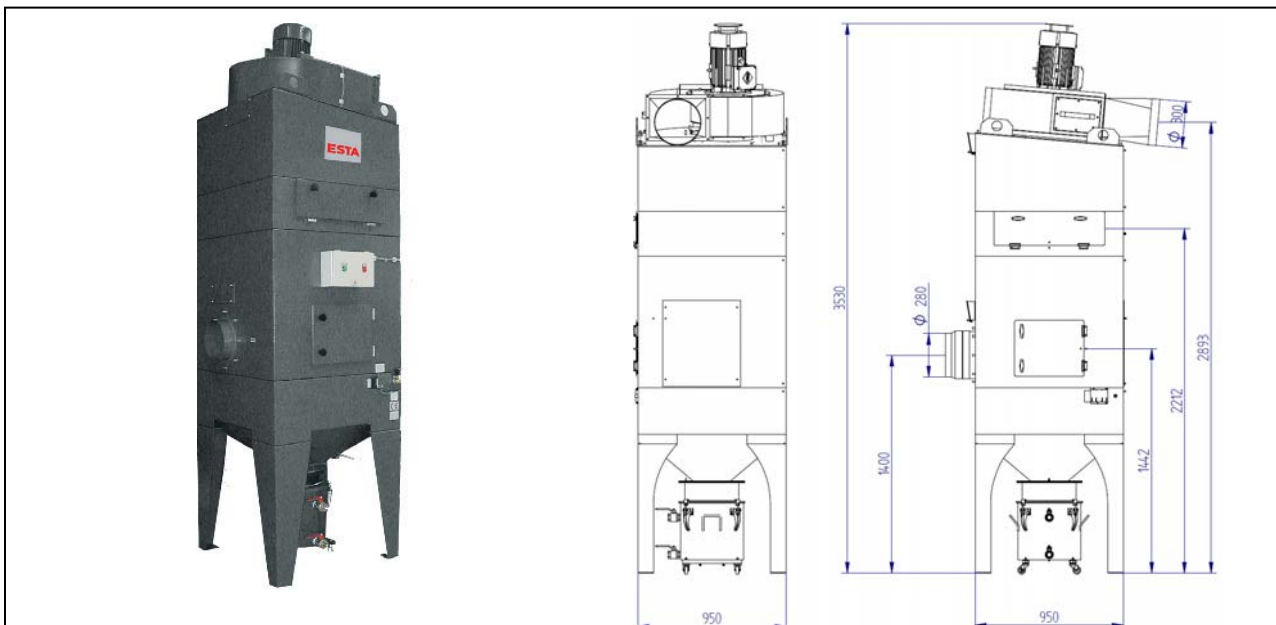

ESTA PLUS

Application range:

Extraction of aluminium dust
Dust extraction at individual or multiple workstations of adhesive and moistly dusts, especially metallic dusts that are sparks generating
As central exhaust station with intercepting pipe and several extraction points

Your benefits at a glance

High suction power for adhesive and moistly dusts
Ideal solution for sparks generating applications

Characteristics:

Completely made of stainless steel
Integrated control cabinet

Optional with special painting

State of the art: 45600-51-00 Subject to change without notice! For remaining questions please do not hesitate to contact us.